

**PLUG**

6	NUT	1	BRASS	NICKEL	
5	HOUSING	1	PBT-94V0 15%GF		BLACK
4	RING	1	P.B.S	SILVER	
3	TIP	1	P.B.S	SILVER	
2	TIP SHUNT	1	BRASS	SILVER	
1	SLEEVE	1	P.B.S	SILVER	
NO	PART NAME	Q'ty	MATERIAL	PLATED	REMARK

**NUT**

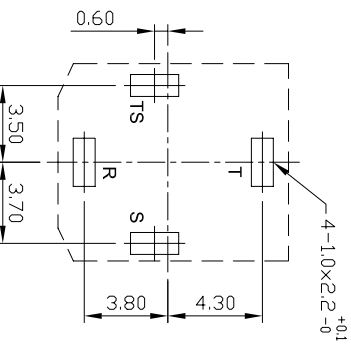
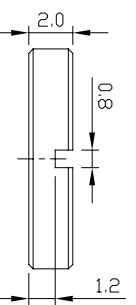
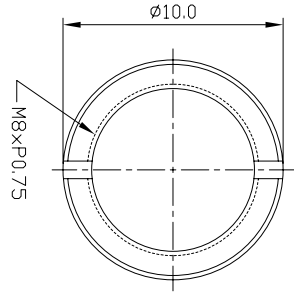

P.C.B LAYOUT (±0.1)  
(BOTTOM VIEW)

LJE0352-B	LJE0352	LJE0352-3RT	LJE0352-4R
O2TS O3T O1S	O2TS O3T	O4R O3T O1S	O4R O2TS O3T O1S
<p><b>LIH SHENG PRECISION INDUSTRIAL CO., LTD.</b></p> <p><b>TOLERANCE</b> X: ±0.5 X.X: ±0.3 X.XX: ±0.15</p> <p><b>PART NAME</b> EARPHONE JACK</p> <p><b>DATE</b> 01/06/93</p> <p><b>SCALE</b> 3:1</p> <p><b>UNIT</b> mm</p> <p><b>CHECK</b> Jacky</p> <p><b>APPROVED</b> Ken</p>			

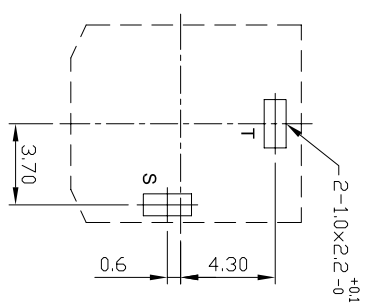
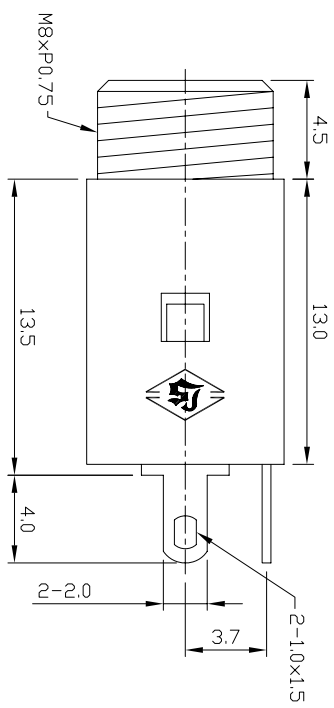
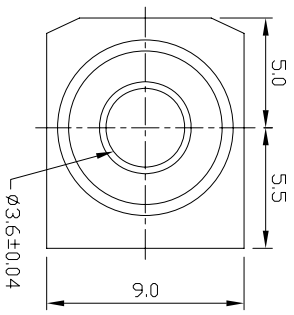

P.C.B LAYOUT (±0.1)  
(BOTTOM VIEW)

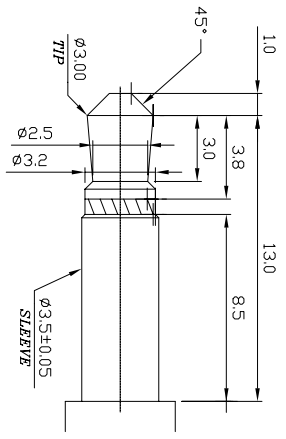
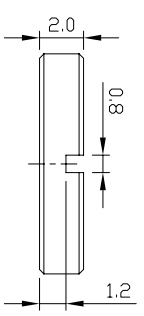
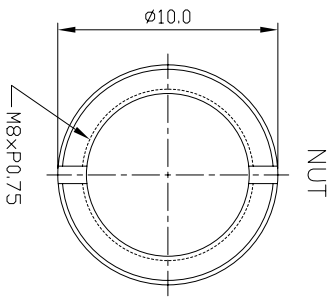
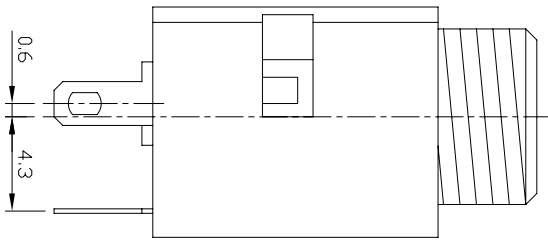

**PLUG**

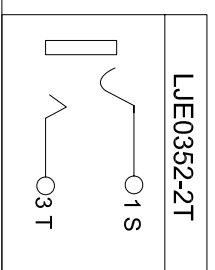

4	NUT	1	BRASS	NICKEL	
3	HOUSING	1	PBT-94V0 15%GF		BLACK
2	TIP	1	P.B.S	SILVER	
1	SLEEVE	1	P.B.S	SILVER	
NO	PART NAME	Q'TY	MATERIAL	PLATED	REMARK



**LIH SHENG PRECISION  
INDUSTRIAL CO., LTD.**

<b>TOLERANCE</b>		<b>MATERIAL</b>		<b>PART NAME</b>	
X	±0.5	EARRPHONE JACK		LJE0352-2T	
X.X	±0.3	Thickmess		PART NO.	
X.XX	±0.15	Disposal		DATE	
UNIT		SCALE		DRAW	
mm		3:1		Chms	
		CHECK		APPROVED	
		Jacky		Ken	