

P.C.B. LAYOUT ( $\pm 0.1$ )  
(BOTTOM VIEW)

3	HOUSING	1	PBT+15%GF	$\Delta$	
2	TIP	1	BRASS	$\Delta$	Sn/Cu
1	SLEEVE	1	IRON SHEET		NICKEL
NO	PART NAME	QTY	MATERIAL	PLATED	REMARK

HISTORY X-COUNT	DATE	ECN NO.	REV.	REVISION	SIGN.
$\Delta$ x1	2005/05/05	N200505003	1.0	CHANGE MATERIAL PBT- PBT+15%GF	CHS
$\Delta$ x2	DEC/17/07		A	1.修正IP材料 - P.B.S.正五層BRASS; 2.將版本自數字改為英文字母 - 100299A版。	CHS
$\Delta$ x1	27/FEB/08		B	更新位碼與內容	CHS
$\Delta$ x1	24/OCT/08		C	修正圖面外觀, 以便與零件相符。	CHS

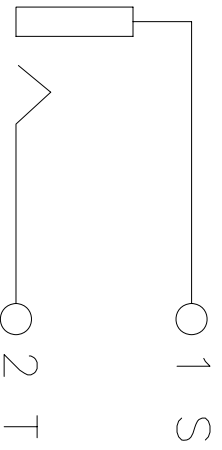
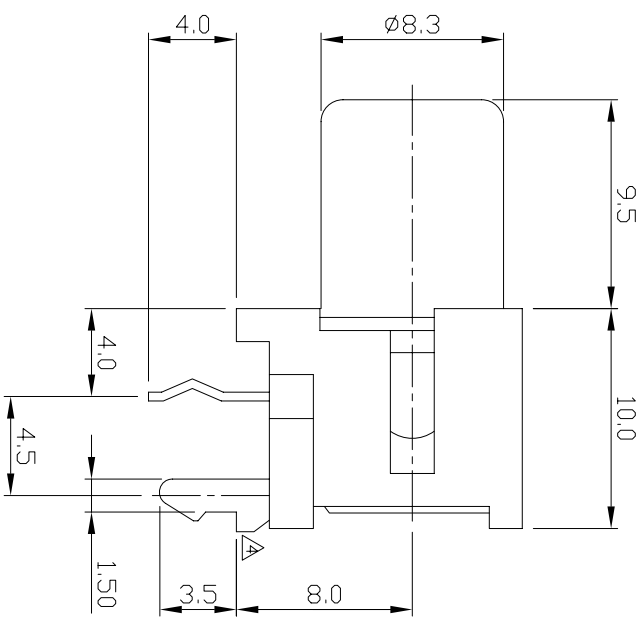

HOUSING COLOR	SLEEVE	PLATED
RED	-2R	-2R-G
BLUE	-2L	-2L-G
WHITE	-2W	-2W-G
BLACK	-2B	-2B-G
GREEN	-2GR	-2GR-G
YELLOW	-2Y	-2Y-G
ORANGE	-2OR	-2OR-G

**LIH SHENG PRECISION INDUSTRIAL CO., LTD.**

TOLERANCE	Material	PART NAME	DATE	CHECK	REV. C
X. $\pm 0.5$	Thickness	PART NO.	12/13/91'	CHECK	APPROVED
X.X $\pm 0.3$	Disposal	SCALE	3:1	Chris	Ken
X.XX $\pm 0.15$	UNIT	SCALE	3:1	Chris	Ken
$\phi$	mm	SCALE	3:1	Chris	Ken

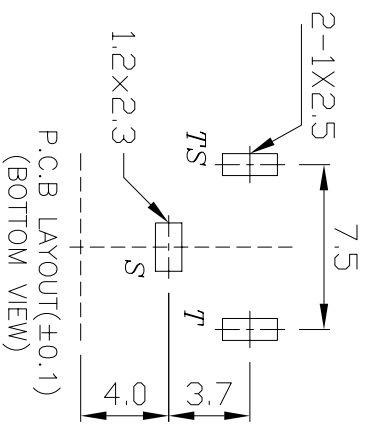
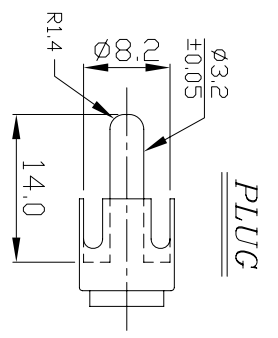
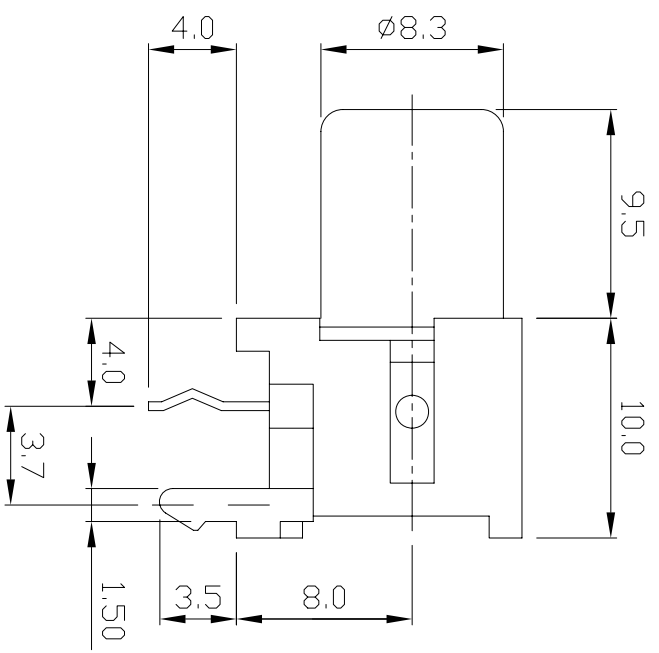
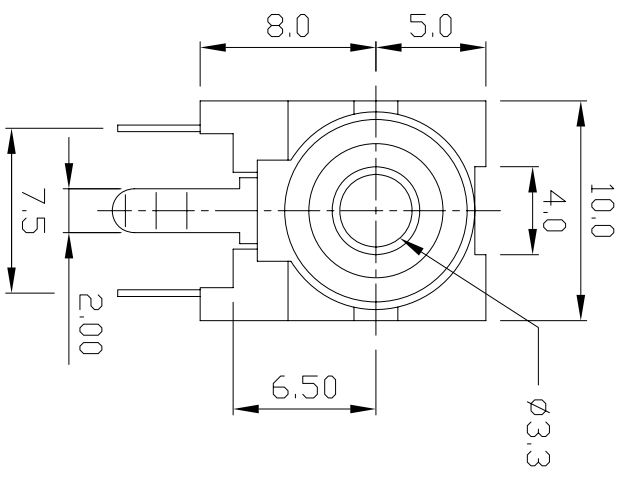

4	HOUSING	1	PBT+15%GF	△	
3	TIP SHUNT	1	BRASS		
2	TIP	1	P.B.S		
1	SLEEVE	1	IRON SHEET		
NO	PART NAME	Q'TY	MATERIAL	PLATED	REMARK



**LIH SHENG PRECISION INDUSTRIAL CO., LTD.**

TOLERANCE		Material		PART NAME	
X. ±0.5	Thickness	RCA JACK		LP-0848A-3	
X.X ±0.3	Disposal	PART NO.		DATE	
X.XX ±0.15	UNIT	SCALE		DRAW	
	mm	3:1		CHRIS	

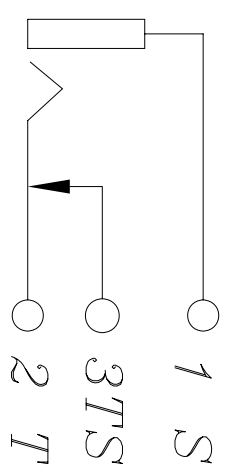

HOUSING COLOR	SLEEVE	PLATED
RED	-3R	-3R-G
BLUE	-3L	-3L-G
WHITE	-3W	-3W-G
BLACK	-3B	-3B-G
GREEN	-3GR	-3GR-G
YELLOW	-3Y	-3Y-G
ORANGE	-3OR	-3OR-G

HISTORY XCOUNT	DATE	ECN NO.	REV.	REVISION	SIGN.
△	2005/05/05	N200505003	1.0	CHANGE MATERIAL PBT→PBT+15%GF	CHRIS
△	27/FEB/08		B	更新圖樣內容	CHRIS

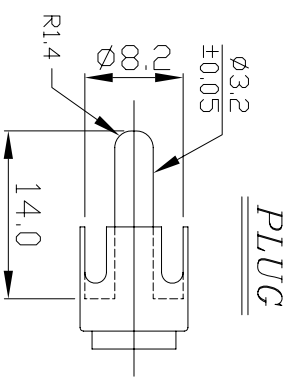
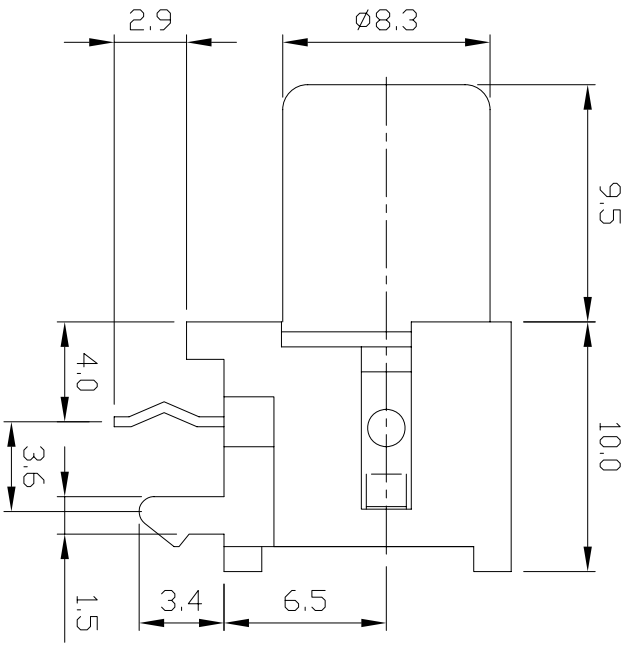
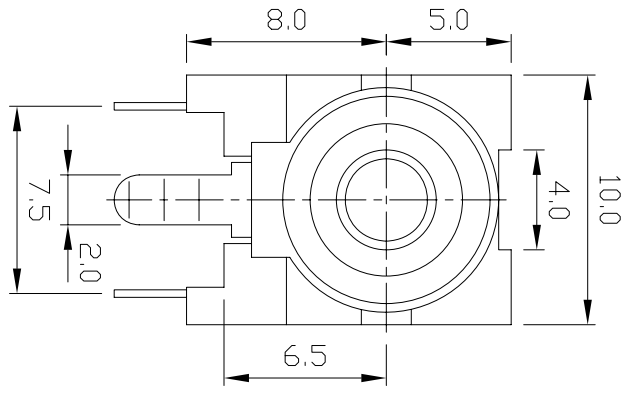

**PLUG**

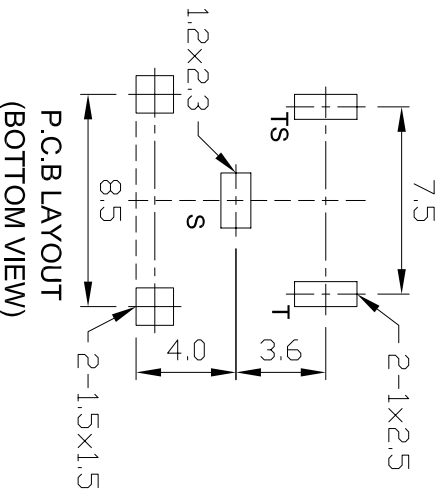

**P.C.B LAYOUT  
(BOTTOM VIEW)**

4	HOUSING	1	PBT+15%GF		
3	TIP SHUNT	1	BRASS	Sn/Cu	
2	TIP	1	P.B.S	Sn/Cu	
1	SLEEVE	1	IRON SHEET	NICKEL	
NO	PART NAME	Q'TY	MATERIAL	PLATED	REMARK

**LIH SHENG PRECISION  
INDUSTRIAL CO., LTD.**

TOLERANCE		Material		PART NAME		RCA JACK	
X.	±0.5	Thickness		PART NO.	<b>LP-0848B-3</b>		
X.X	±0.3	Disposal		DATE	07/18/06		
X.XX	±0.15	UNIT	SCALE	DRAW	CHECK	APPROVE	
		mm	3:1	CHRIS	KEN	COOPER	

1	S	HOUSING	SLEEVE PLATED
3	TS	COLOR	NI
2	T	RED	-3R
		BLUE	-3L
		WHITE	-3W
		BLACK	-3B
		GREEN	-3GR
		YELLOW	-3Y
		ORANGE	-3OR