

PLUG

3	HOUSING	1	PBT+15%GF	Δ		
2	TIP	1	BRASS	Δ	Sn/Cu	
1	SLEEVE	1	IRON SHEET		NICKEL	
NO	PART NAME	QTY	MATERIAL	PLATED	REMARK	

P.C.B LAYOUT(± 0.1)
(BOTTOM VIEW)

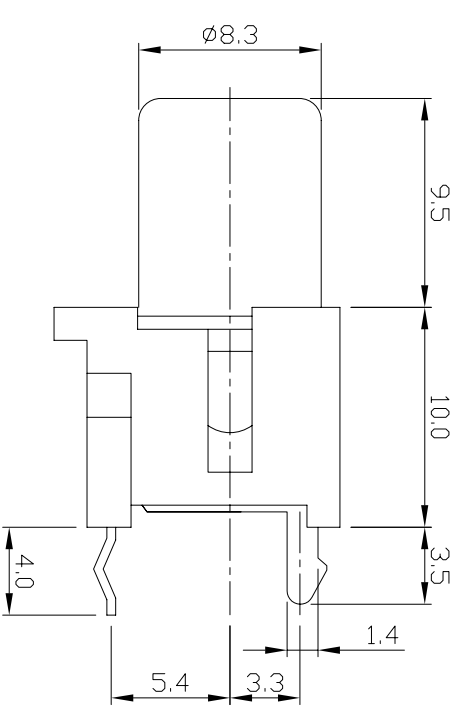
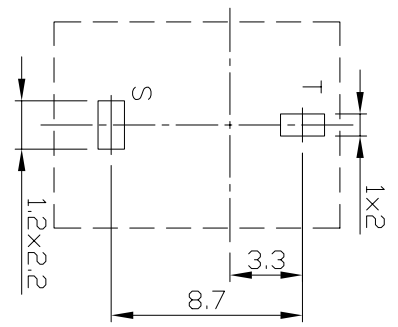

		LH SHENG PRECISION INDUSTRIAL CO., LTD.	
HOUSING		SLEEVE PLATED	
COLOR		NI	
RED	-2R	-2R-G	
BLUE	-2L	-2L-G	
WHITE	-2W	-2W-G	
BLACK	-2B	-2B-G	
GREEN	-2GR	-2GR-G	
YELLOW	-2Y	-2Y-G	
ORANGE	-2OR	-2OR-G	

TOLERANCE		PART NAME	
X	± 0.5	RCA JACK	
X.X	± 0.3	LP-0848-2	
X.XX	± 0.15	DATE	
		12/13/91'	
Material		CHECK	
Thickness		Ken	
Disposal		APPROVED	
UNIT		Cooper	
SCALE			
3:1			

HISTORY X-COUNT	DATE	ECN NO.	REV.	REVISION	SIGN.
Δ x1	2005/05/05	N200505003	1.0	CHANGE MATERIAL PBT--PBT+15%GF	CHS
Δ x2	DEC/17/07		A	1.修改銅鍍層，P.R.S.用正牌BRASS； 2.修改本圖數字改為英文數字，100改為A版。	CHS
Δ x1	27/FEB/08		B	更新色碼表內容	CHS

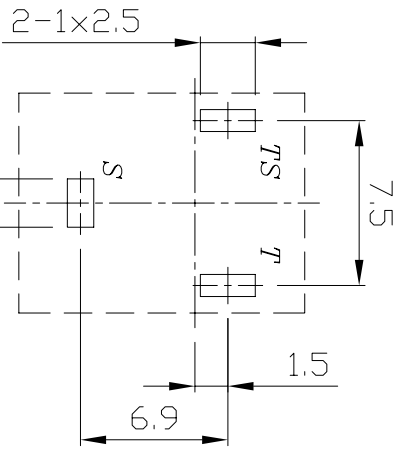
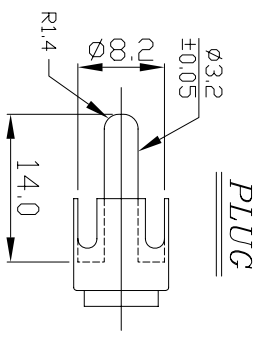
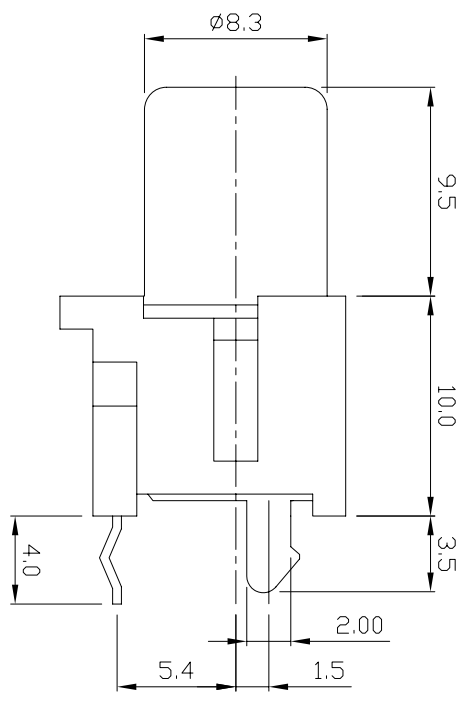
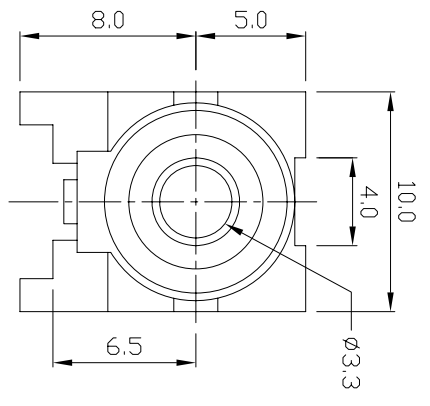

P.C.B. LAYOUT(±0.1)
(BOTTOM VIEW)

4	HOUSING	1	PBT+15%GF	△	
3	TIP SHUNT	1	BRASS		
2	TIP	1	P.B.S		
1	SLEEVE	1	IRON SHEET		
NO	PART NAME	QTY	MATERIAL	PLATED	REMARK

HISTORY XCOUNT	DATE	ECN NO.	REV.	REVISION	SIGN.
△	2005/05/05	N200505003	1.0	CHANGE MATERIAL PBT→PBT+15%GF	CHRIS
△	27/FEB/08		A	更新色碼表內容	CHRIS

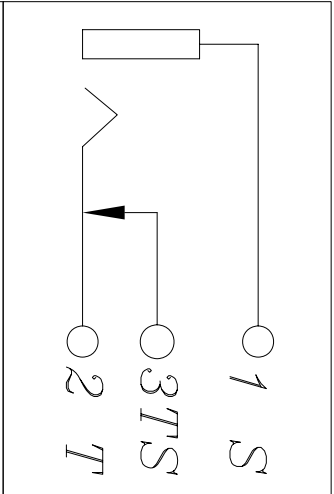

HOUSING COLOR	SLEEVE NI	PLATED AU/2u"
RED	-3R	-3R-G
BLUE	-3L	-3L-G
WHITE	-3W	-3W-G
BLACK	-3B	-3B-G
GREEN	-3GR	-3GR-G
YELLOW	-3Y	-3Y-G
ORANGE	-3OR	-3OR-G



LIH SHENG PRECISION INDUSTRIAL CO., LTD.

TOLERANCE	Material	PART NAME	RCA JACK	180°/H10
X. ±0.5	Thickness	PART NO.	LP-0848-3	
X.X ±0.3	Disposal	DATE	12/13/91	REV.A
X.XX ±0.15	UNIT	DRAW	CHECK	APPROVE
⊕	mm	CHRIS	KEN	COOPER
⊕		SCALE	3:1	